

KH 660-840

Saatbettkombination / combination

Ausgabe: A_0109 Version: 01.10

KNOCHE
Maschinenbau GmbH
31542 Bad Nenndorf
Tel.: +49-5723-9476-70
Fax: +49-5723-9476-86
info@knoche-maschinenbau.de
www.knoche-maschinenbau.de

ERSATZTEILLISTE
SPARE PART LIST
LISTE DE PIÈCES

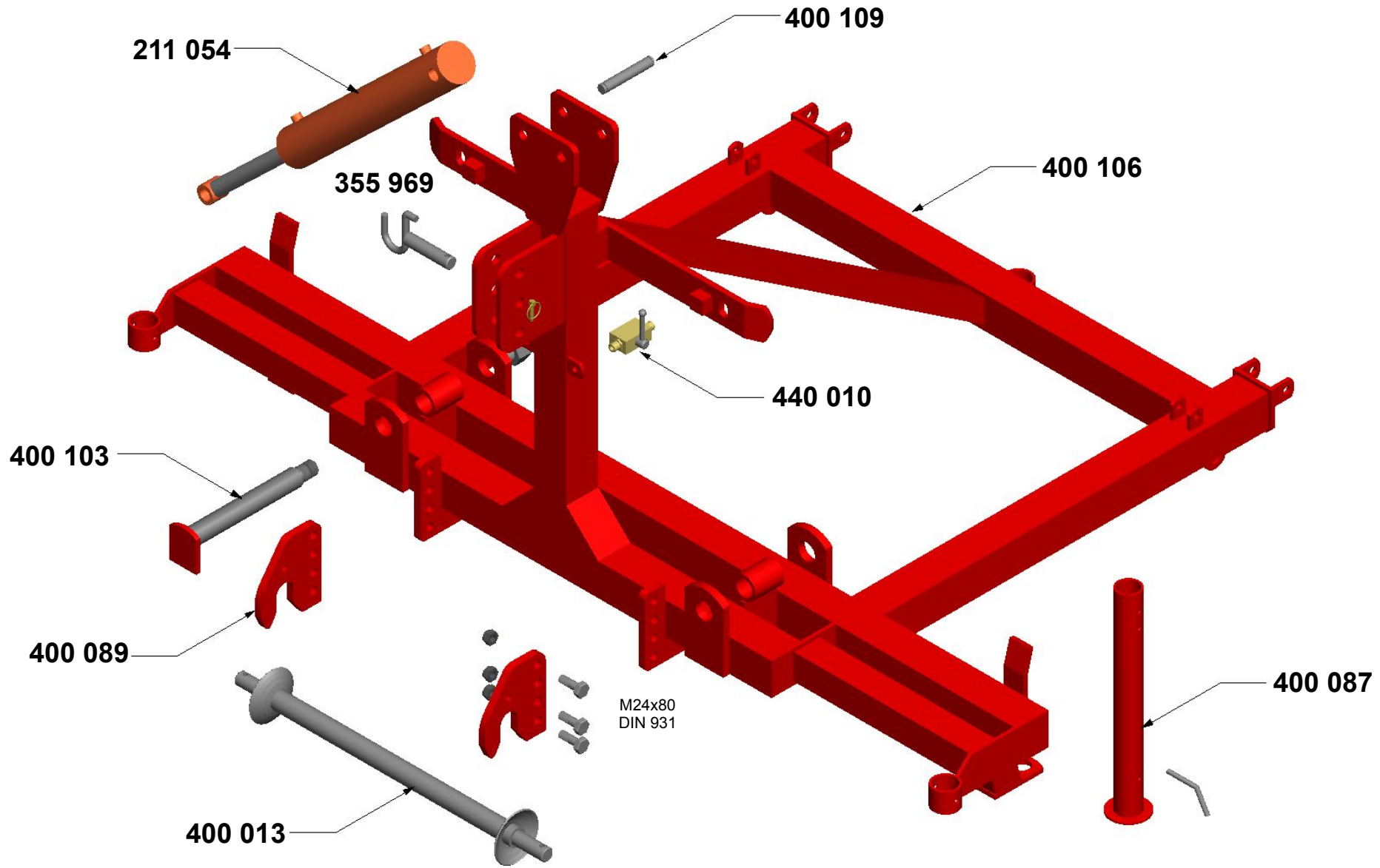



Typ		KH 660-840	Baugruppe/ section/ groupe	Hauptrahmen		
POS	ID / part-no. réf. article	Benennung / description dénomination	Notiz / note note	Gewicht [kg] weight / poids	Preis [€] price / prix	
	211 054	HD-Zylinder 80 x 500 - 6000		18		
	355 969	Oberlenkerbolzen DS KAT III		3,4		
	400 013	Fangwelle Ø 50 KAT III - 1000 lg		15		
	400 087	Abstellstütze KH 660-840 mit Stecker		5,2		
	400 089	Anschlußplatte Fangwelle (KH 660-840)		6		
	400 106	Hauptrahmenkörper KH 660-840		302		
	400 107	Hydraulikschlauch 500 lg DN 06 DKL-DKL90°				
	400 108	Hydraulikschlauch 800 lg DN 06 DKL-DKL90°				
	400 109	Nutbolzen Ø 25 - 140 - 155		0,6		
	400 130	Distanzhülse Ø 33,7 - ø 25 - 25		0,08		
	440 008	Hydraulikschlauch 1200 lg R 1/4", 1St DN06 DKL/AGR				
	440 009	Hydraulikstecker CE 8 L				
	440 010	Kugelhahn CE8L/CE8L-Schott				
	606 711	Drosselplättchen 7,8 B=1,2, 1,5, od. 1,8 mm		0,01		

Ausgabe: A_0109 • Preisstand: PL112 • Ersatz für: *

KNOECHE Maschinenbau GmbH • Tel.: +49-(0)-5723-9476-70 • Fax: +49-(0)-5723-9476-86 • www.knoeche-maschinenbau.de

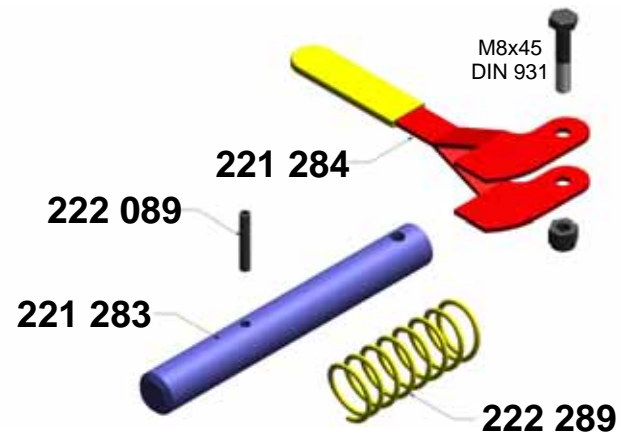
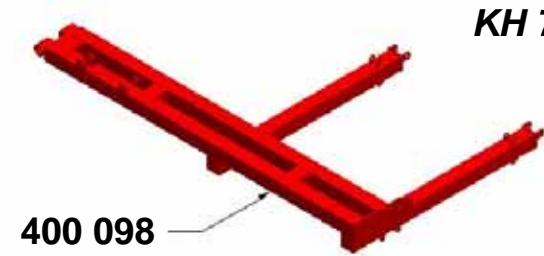
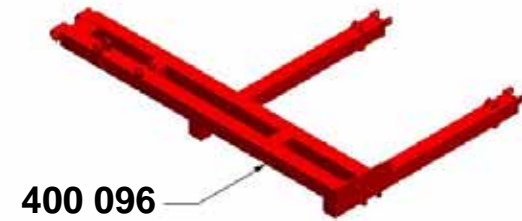
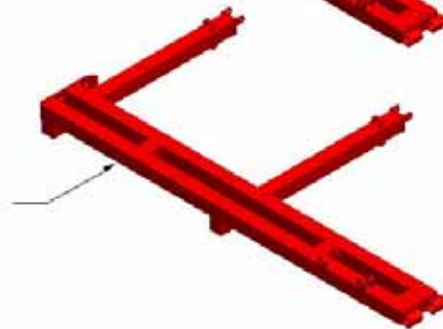
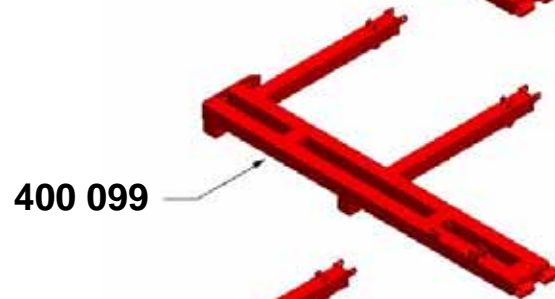
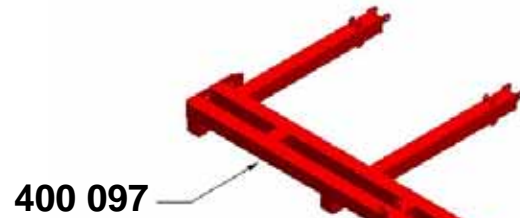
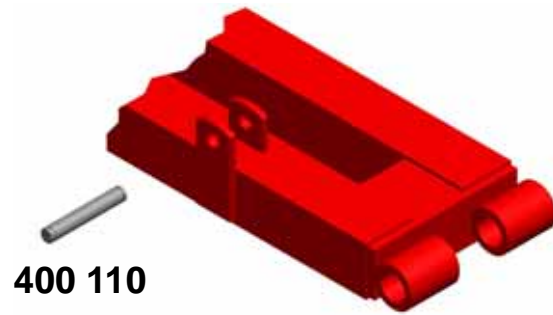

KH 660

KH 720

KH 840



Typ		KH 660-840	Baugruppe/ section/ groupe	Auslegarme		
POS	ID / part-no. réf. article	Benennung / description dénomination	Notiz / note note	Gewicht [kg] weight / poids	Preis [€] price / prix	
	221 283	Verriegelungsbolzen 25x200		0,95		
	221 284	Verriegelungshebel		0,2		
	222 089	Spannstift 6x36 DIN1481 vz				
	222 289	Druckfeder 3 x 30 x 90		0,1		
	400 096	Auslegarm KH 660 li				
	400 097	Auslegarm KH 660 re				
	400 098	Auslegarm KH 720 li				
	400 099	Auslegarm KH 720 re				
	400 100	Auslegarm KH 840 li		215		
	400 101	Auslegarm KH 840 re		215		
	400 110	Nutbolzen Ø 25 - 140 - 155		0,6		

KNOECHE Maschinenbau GmbH • Tel.: +49-(0)-5723-9476-70 • Fax: +49-(0)-5723-9476-86 • www.knoeche-maschinenbau.de

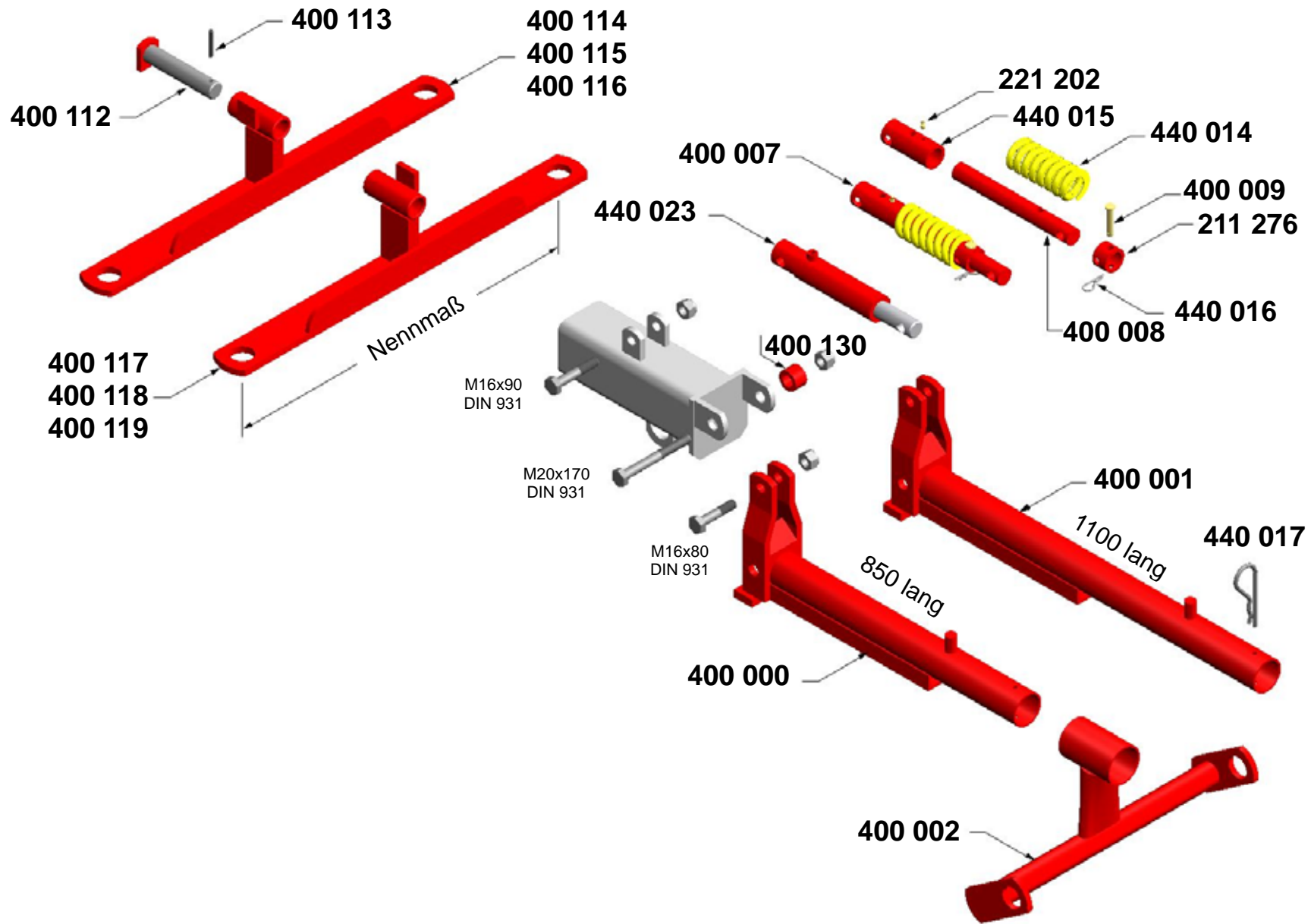

Typ	KH 660-840		Baugruppe/ section/ groupe	Druckarm, Federpaket, Pendel		
POS	ID / part-no. réf. article	Benennung / description dénomination	Notiz / note note	Gewicht [kg] weight / poids	Preis [€] price / prix	
	211 276	Stellring - Federpaket KH		0,13		
	221 202	Schmiernippel 6 x 1		0,002		
	400 000	Druckarm, 850 lg, SBK		12		
	400 001	Druckarm, 1100 lg, SBK		13,2		
	400 002	Pendel, symetrisch, SBK		3,8		
	400 007	Federpaket KH + SKM		2,96		
	400 008	Druckbolzen KH		1,3		
	400 009	Sicherungsbolzen 10 x 60		0,05		
	400 112	Pendelbolzen Ø 30 - 125 - 155, SBK		0,86		
	400 113	Spannstift 8 x 50				
	400 114	Zugpendel vorne links 550		6,9		
	400 115	Zugpendel vorne links 700		7,8		
	400 116	Zugpendel vorne links 800		8,5		
	400 117	Zugpendel vorne rechts 550		6,9		
	400 118	Zugpendel vorne rechts 700		7,8		
	400 119	Zugpendel vorne rechts 800		8,5		
	400 130	Distanzhülse Ø 33,7 - ø 25 - 25		0,08		
	440 014	Feder 55x121 mm, Draht12,2		1,47		
	440 015	Federanschlag KH		0,43		
	440 016	Federstecker 3mm, verzinkt		0,007		
	440 017	Federstecker 5,5 mm, verzinkt		0,02		
	440 023	Hydraulikzylinder Plunger KH 660-720-840		8,6		

Ausgabe: A_0109 • Preisstand: PL112 • Ersatz für: *

KNOCHEN Maschinenbau GmbH • Tel.: +49-(0)-5723-9476-70 • Fax: +49-(0)-5723-9476-86 • www.knoche-maschinenbau.de

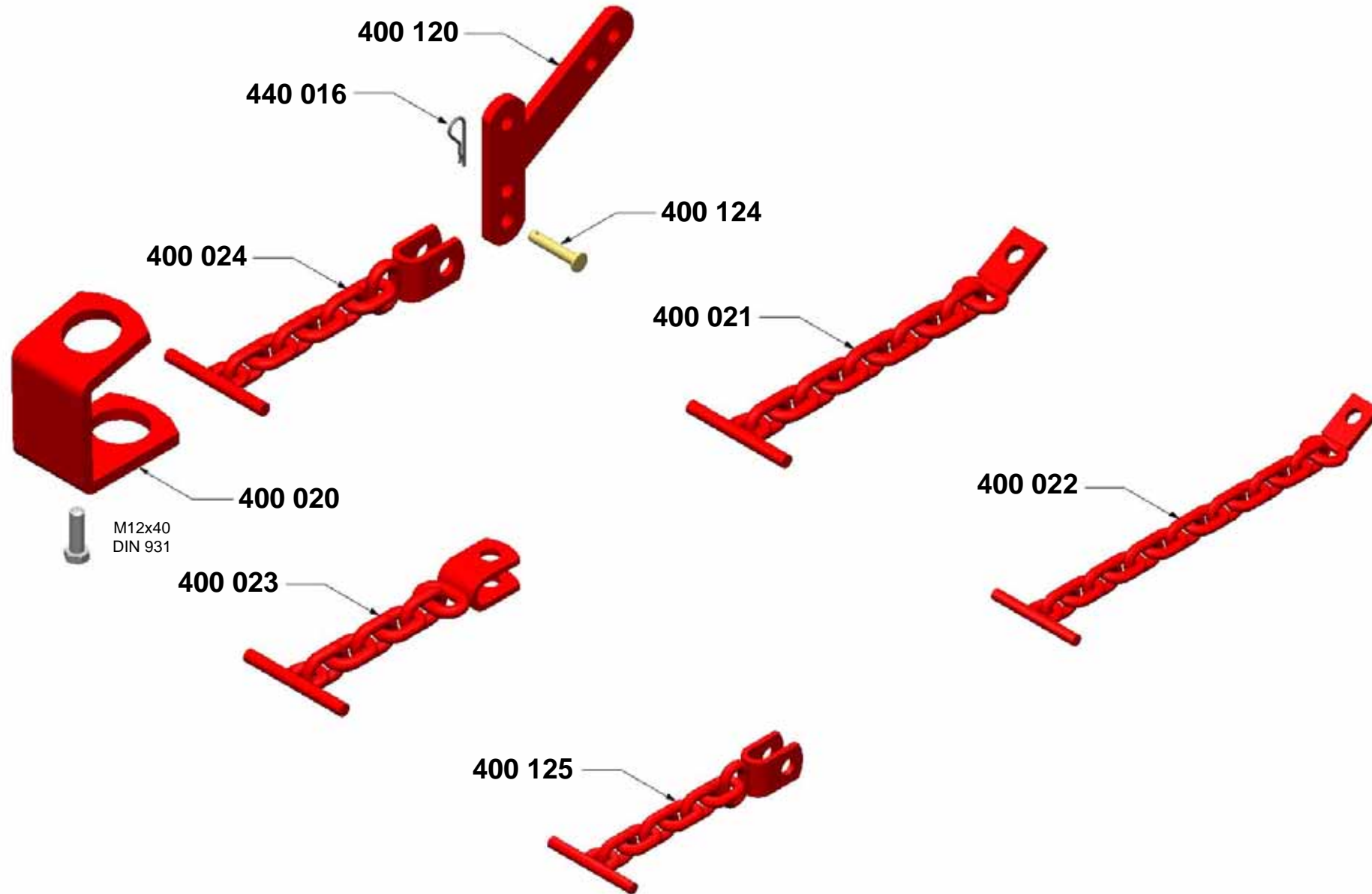

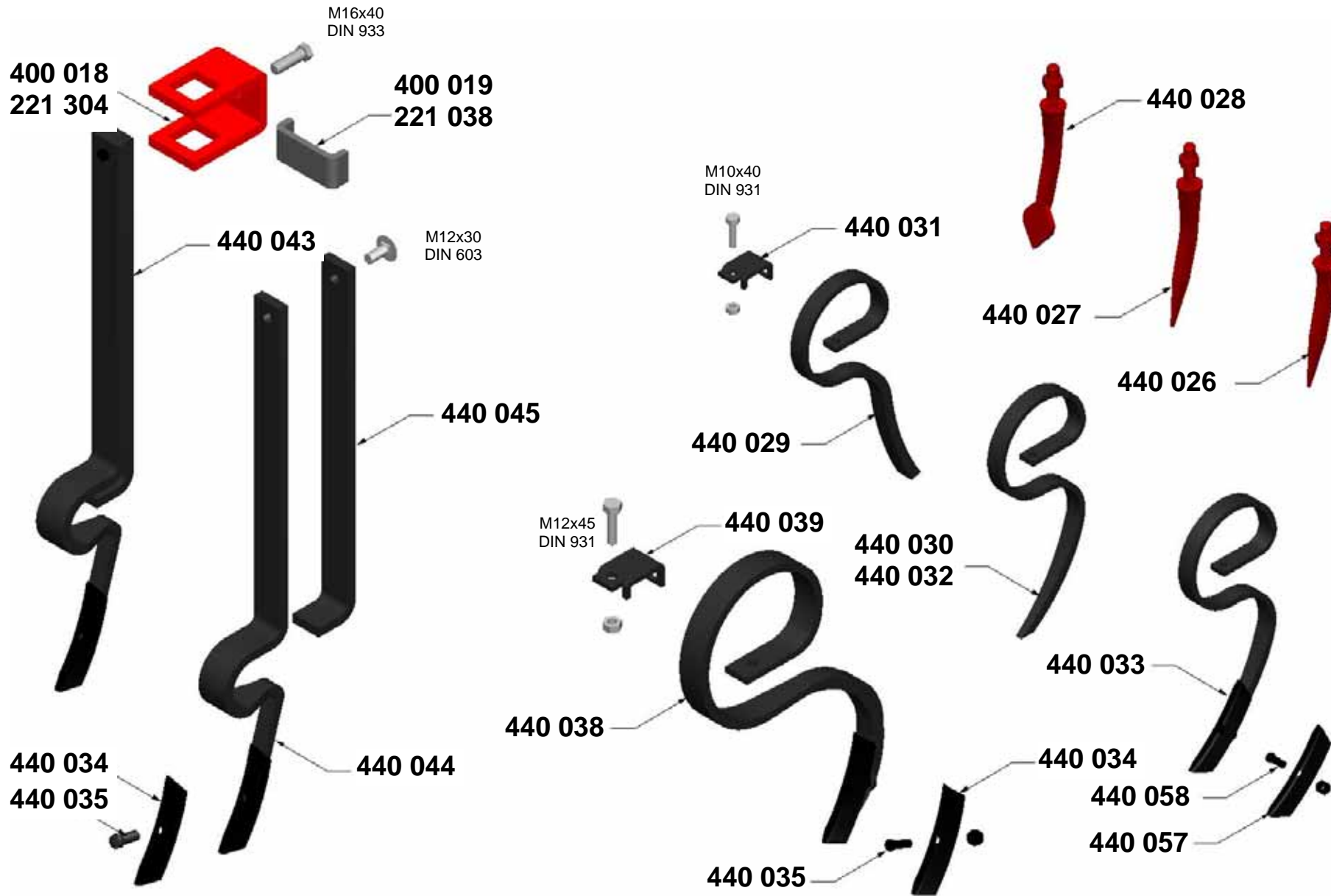

Typ	KH 660-840		Baugruppe/ section/ groupe	Spurlockerer, Zinken		
POS	ID / part-no. réf. article	Benennung / description dénomination	Notiz / note note	Gewicht [kg] weight / poids	Preis [€] price / prix	
	221 038	Druckstück für Rohr 80		0,27		
	221 304	Klammer f. Spurlockerer 80		3		
	400 018	Klammer 40		1,35		
	400 019	Druckstück für Klammer 40		0,3		
	440 035	Planetschraube M10 x 40, 8.8 blank		0,038		
	440 043	Spurlockerer 40x10, kompl.		4,73		
	440 044	Spurlockerer 40 x 10 mit Schar		3,05		
	440 045	Verstärkungsfeder 40 x 10 für Spurlockerer		1,68		
	440 046	Ersatzschar 35 x 6 x 195		0,31		
	440 026	Ackereggzinken 18 x 190 Standard mit M 16		0,42		
	440 027	Konuszinken 22 x 220 mit M 16		0,62		
	440 028	Löffelzinken 20 x 200 mit M 16		0,85		
	400 015	Gareeggenrahmen KG 110				
	400 016	Gareeggenrahmen KG 140				
	440 029	Gareeggenzinken 25x8, 1.R.		0,98		
	440 030	Gareeggenzinken 25x8		1,1		
	440 031	Halter für Gareeggenzinken		0,1		
	440 032	Gareeggenzinken 26x10 verstärkt		1,25		
	440 033	Gareeggenzinken 25 x 8 mit auswechselbarem Schar		1,22		
	440 057	Ersatzschar für Gareezinken		0,19		
	440 058	Ersatzschraube 8 x 33		0,03		
	400 122	PF-Eggentragrahmen PF 110				
	400 123	PF-Eggentragrahmen PF 140				
	440 034	Ersatzschar 40x6x195 für PF-Zinken		0,31		
	440 035	Planetschraube M10 x 40, 8.8 blank		0,038		
	440 038	PF-Zinken mit Schar		2,8		
	440 039	Halter für PF-Zinken		0,23		

